

CINTRO

CINTRO



REYNAERS
aluminium

CINTRO



Constructie CINTRO
Construction CINTRO
Construction CINTRO
Konstruktion CINTRO

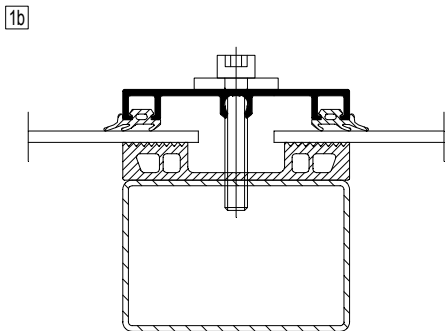
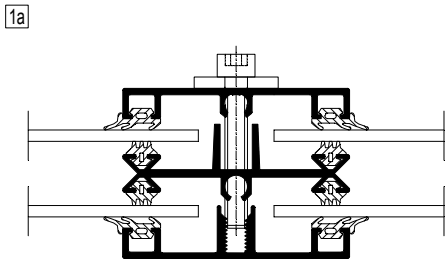
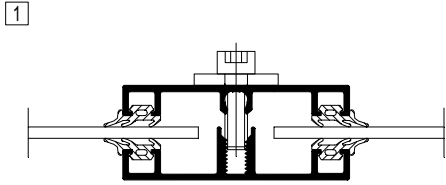
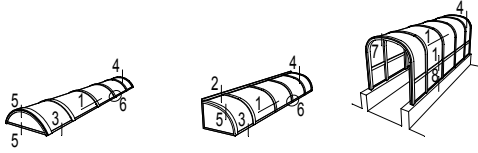

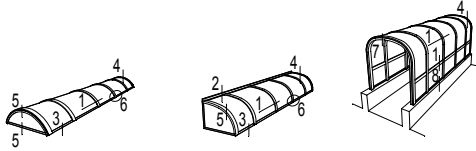

021.4534.XX

$I_x = 0.212 \text{ cm}^4$

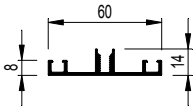

1 CINTRO-001001.dxf
 CINTRO-001001.dwg

1a CINTRO-001005.dxf
 CINTRO-001005.dwg

021.4535.XX

$I_x = 1.476 \text{ cm}^4$

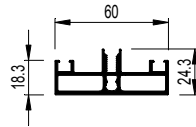

1 CINTRO-001002.dxf
 CINTRO-001002.dwg

1a CINTRO-001006.dxf
 CINTRO-001006.dwg

021.4532.XX

$I_x = 3.664 \text{ cm}^4$

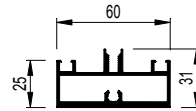

1 CINTRO-001003.dxf
 CINTRO-001003.dwg

1a CINTRO-001007.dxf
 CINTRO-001007.dwg

021.4531.XX

$I_x = 9.837 \text{ cm}^4$

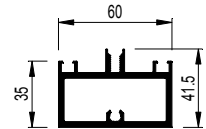

1 CINTRO-001004.dxf
 CINTRO-001004.dwg

1a CINTRO-001008.dxf
 CINTRO-001008.dwg

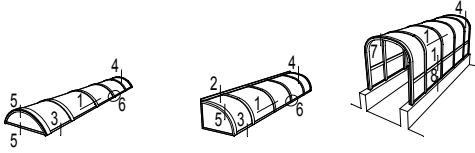

2

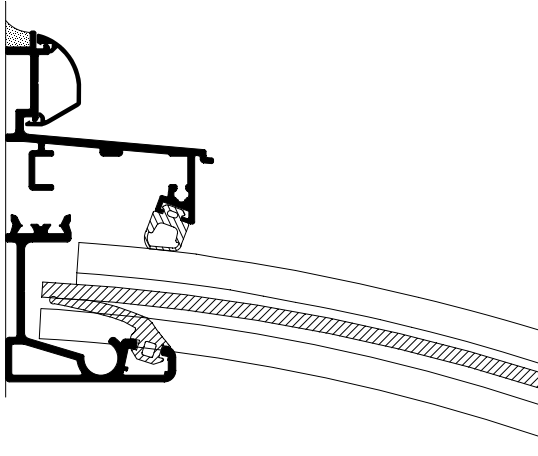

CINTRO-002001.dxf
CINTRO-002001.dwg

3

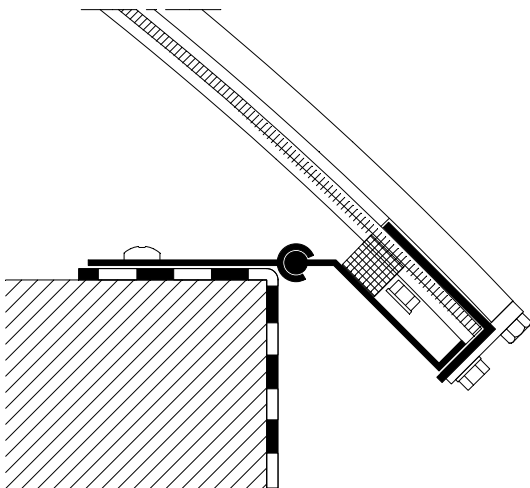

CINTRO-003001.dxf
CINTRO-003001.dwg

3

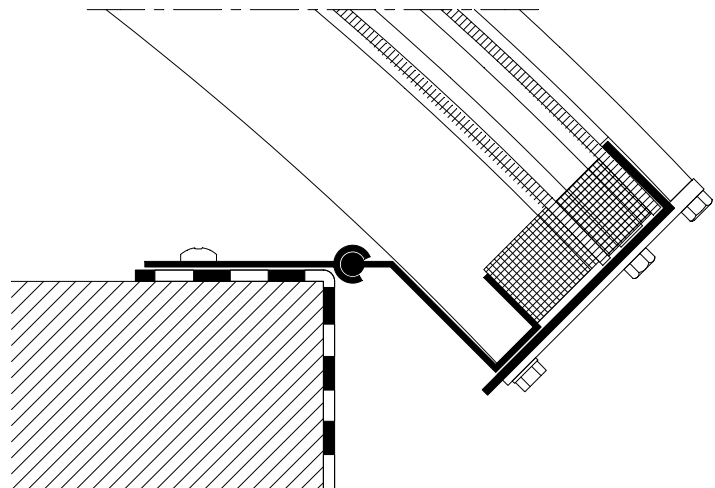

CINTRO-003002.dxf
CINTRO-003002.dwg

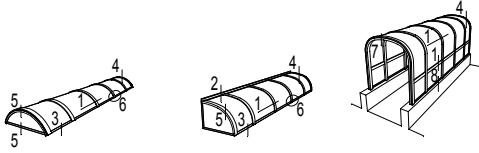

4

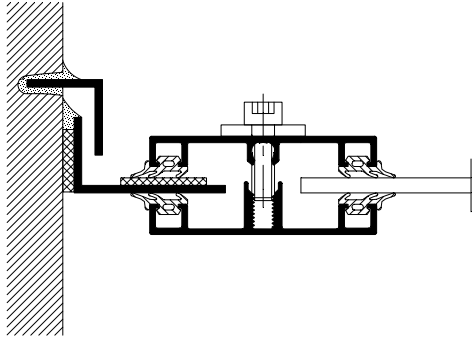

CINTRO-004001.dxf
CINTRO-004001.dwg

4

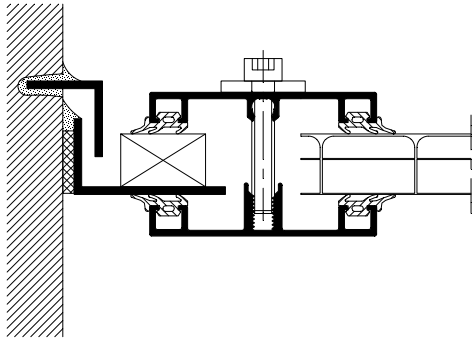

CINTRO-004002.dxf
CINTRO-004002.dwg

4

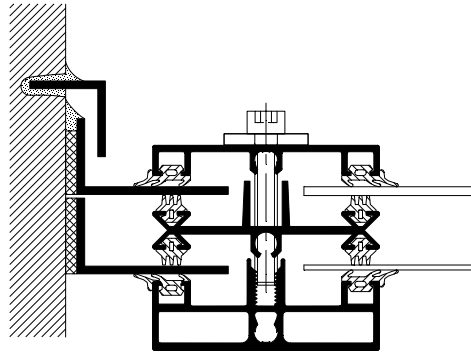

CINTRO-004003.dxf
CINTRO-004003.dwg

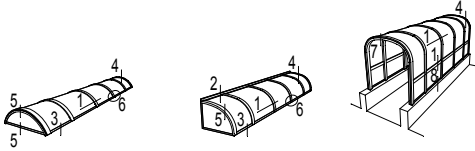

5

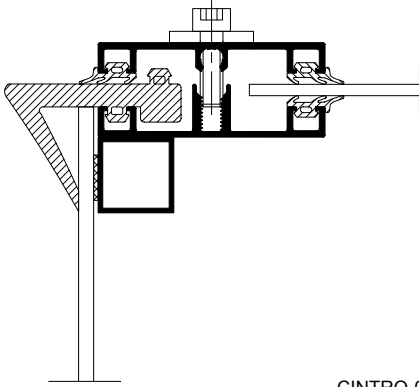

CINTRO-005001.dxf
CINTRO-005001.dwg

5

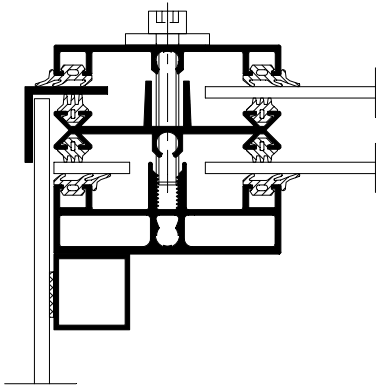

CINTRO-005002.dxf
CINTRO-005002.dwg

5

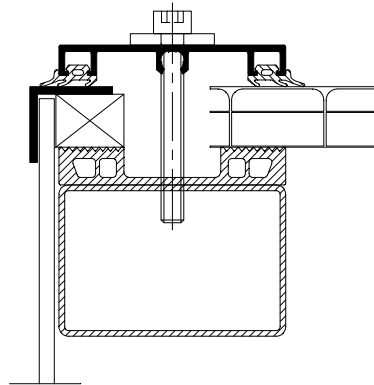

CINTRO-005003.dxf
CINTRO-005003.dwg

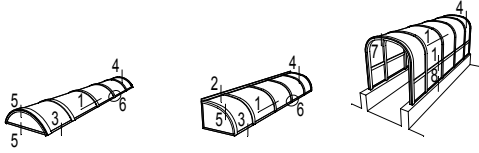

6

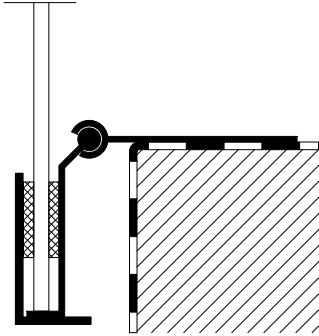

CINTRO-006001.dxf
CINTRO-006001.dwg

6

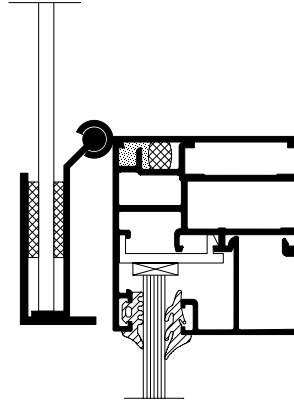

CINTRO-006002.dxf
CINTRO-006002.dwg

7

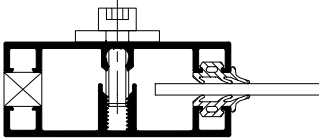

CINTRO-007001.dxf
CINTRO-007001.dwg

7

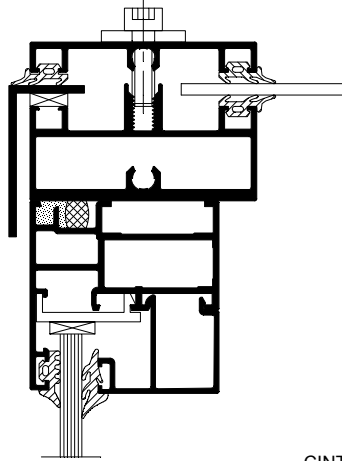

CINTRO-007002.dxf
CINTRO-007002.dwg

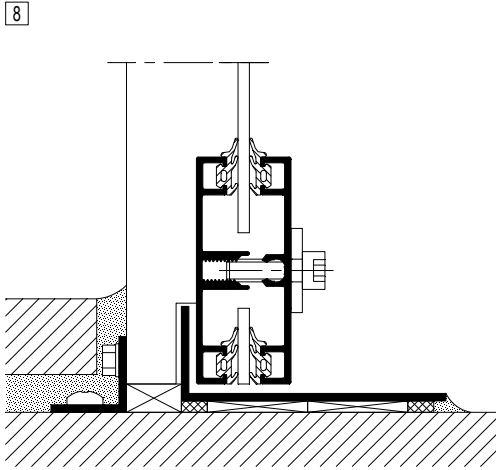
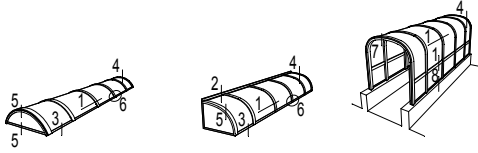

CINTRO-008001.dxf
CINTRO-008001.dwg

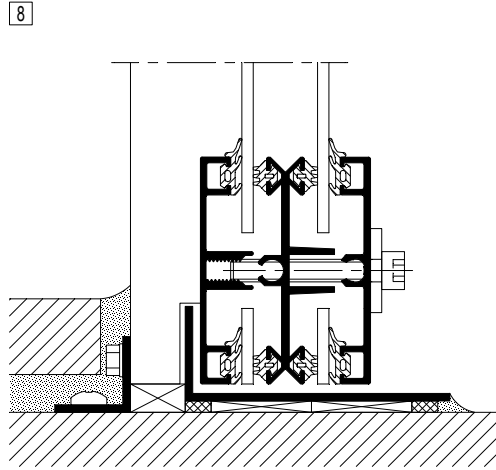

CINTRO-008002.dxf
CINTRO-008002.dwg

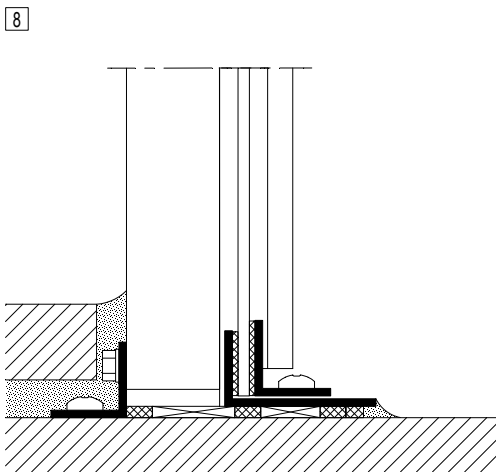

CINTRO-008001.dxf
CINTRO-008001.dwg